

TILL-EASE

43" FIELD CULTIVATOR / CHISEL PLOW



OWNER'S MANUAL

With Assembly Instructions

For Model: 543

KUNZ ENGINEERING, INC. / MENDOTA, IL 61342 / PH (815) 539-6954



12/20



⚠ WARNING

Read & understand operators manual before using this machine.
Failure to follow operating instructions could result in death or serious injury.

TABLE OF CONTENTS

SAFETY INTRODUCTION	2
Safety Alert Symbol	2
Safety Information	3
ASSEMBLY INSTRUCTIONS	4
Items Included	4
Assembly of Tongue	4
Installation of the Lift Control Wiring Assembly	5
OPERATION AND ADJUSTMENTS	6
Intended Use	6
Leveling the Tool	6
Coulter Function	7
Selecting the Proper Sweep	7
Adjusting the Shanks and Coulter Shanks	8
Suggestions for Proper Operation	9
SERVICE PARTS	12
Parts List	12
Parts Drawing	13
WARRANTY STATEMENT	14

SAFETY INTRODUCTION

READ AND UNDERSTAND OWNER'S MANUAL BEFORE USING THIS MACHINE.

All operators of this equipment must read and completely understand all safety information, operating instructions and maintenance. Failure to properly operate and maintain this mower could result in serious injury or death to the operator or bystanders.

Your safety, and the safety of others, is very important. To help you make informed decisions about safety, we have provided operating procedures and other information in this manual. This information alerts you to potential hazards that could hurt you or others.



This safety alert symbol is used to indicate safety instructions. Follow these instructions to avoid personal injury and/or property damage. Read and follow all instructions in this manual and the included engine manual.

You will find important safety information in the following form:

Safety Messages – preceded by a safety alert symbol  and one of three signal words: **DANGER**, **WARNING**, or **CAUTION**.

These signal words mean:



Indicates an imminently hazardous situation that, if not avoided, will result in death or serious injury. This signal word is to be limited to the most extreme situations typically for machine components which, for functional purposes, cannot be guarded.



Indicates a potentially hazardous situation that, if not avoided, could result in death or serious injury, and includes hazards that are exposed when guards are removed. It may also be used to alert against unsafe practices.



Indicates a potentially hazardous situation that, if not avoided, may result in minor or moderate injury. It may also be used to alert against unsafe practices.

This entire manual is filled with important safety information. Please read it carefully.

If you have any questions or concerns regarding the information in this owner's manual please contact Kunz Engineering at 815-539-6954.

IMPORTANT SAFETY INFORMATION

⚠️ WARNING

Do not allow anyone to operate this equipment who has not fully read and comprehended the safety manual and who has not been properly trained in the safe operation of the equipment.

⚠️ WARNING

Operator should be familiar with all functions of the unit.

⚠️ WARNING

Keep bystander clear while operating equipment.

⚠️ CAUTION

Only operate the tillage tool's electric lift while seated on tow vehicle.

⚠️ WARNING

Do not store extra coulters or sweeps in an upside down position in the shank receivers.

⚠️ WARNING

Never carry children or passengers.

⚠️ CAUTION

Lower implement, stop engine, set brake and remove key before servicing, adjusting, repairing or unplugging.

⚠️ CAUTION

Safely support and secure implement before making repairs.

⚠️ CAUTION

Do not stand or climb on equipment.

⚠️ WARNING

Follow all safety precautions outlined by the manufacturer of the tow vehicle being used to pull this product.

This entire manual is filled with important safety information. Please read it carefully.

**FOR QUESTIONS, COMMENTS OR
TROUBLESHOOTING
PLEASE CONTACT
KUNZ ENGINEERING INC. AT
(815) 539-6954**

ASSEMBLY INSTRUCTIONS

Read the complete assembly instructions before starting the assembly.

You should have:

- one tillage tool assembly
- one lift control wiring assembly
- five 9" cultivator sweeps with five bevel washer spacers

A. ASSEMBLY OF TONGUE



Steps 1 and 2 should be performed with caution. Care should be taken to prevent back injuries or other lifting related injuries.

1. The crated tillage tool should have arrived in a vertical position. Lay the crate down with the tires positioned towards the ground. Remove the crate and position the tillage tool on it's side. Remove the center coultter assembly by removing the wire lock pin. At this time the tongue can be rotated in a counter-clockwise direction towards the front of the tillage tool assembly. Reinstall the center coultter assembly and fasten securely with the wire lock pin that was previously removed. **(See Figure 1.)**

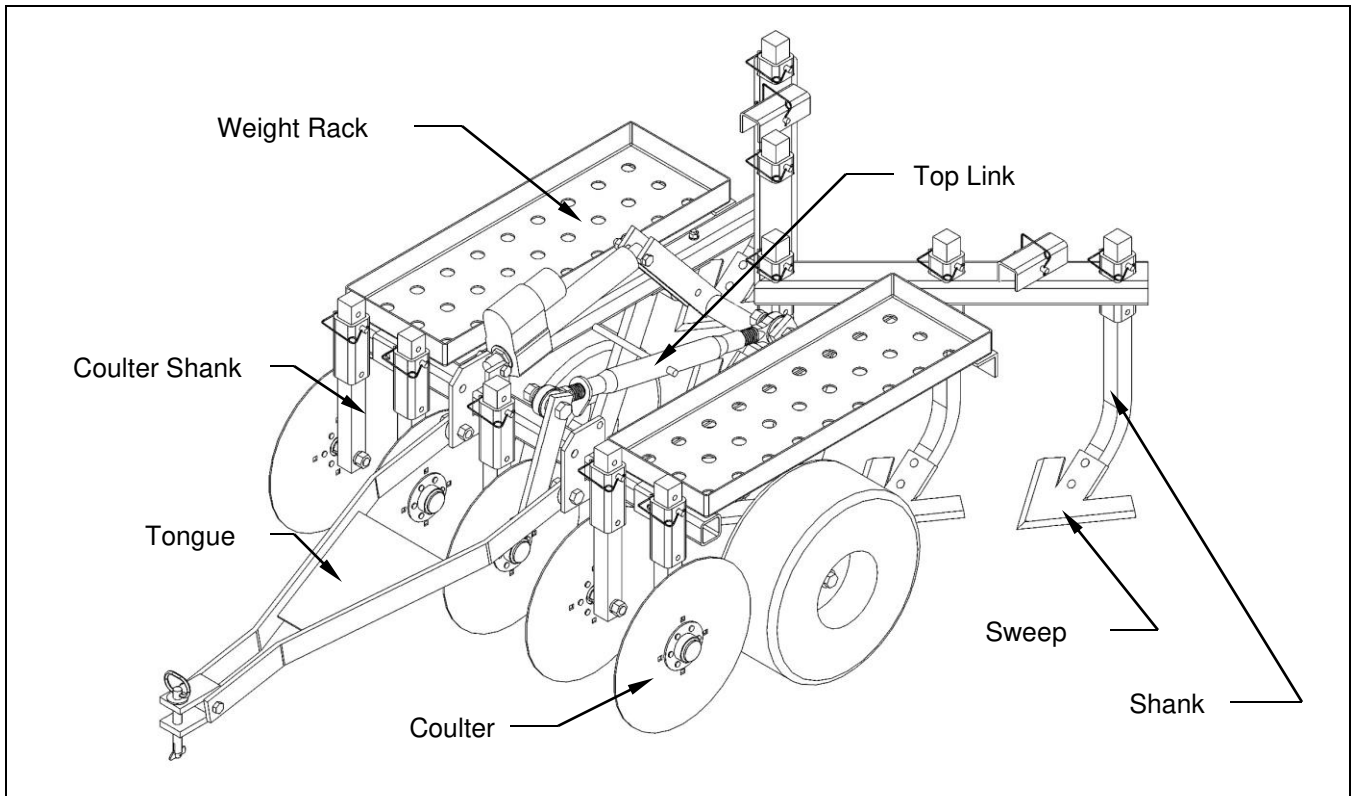

Figure 1. – Tillage Tool Parts

2. Position the tillage tool assembly upright on the tires.
3. Measure the hitch height on your tow vehicle. For hitch heights of 11" or less use the lower tongue mounting holes. For hitch heights of greater than 11" use the upper tongue mounting holes. **(See Figure 2.)** The factory tongue setting is in the lower position. To reposition the tongue remove the provided 5/8" x 2" bolts, lock washers and nuts, align proper holes and reinstall and secure the bolts, lock washers and nuts.
4. Remove the provided 3/4" x 3 bolt , lock washer, and nut from the loose end of the top link. Align the top link with the free arm on the tongue. Install and securely fasten the bolt, lock washer and nut that was previously removed.

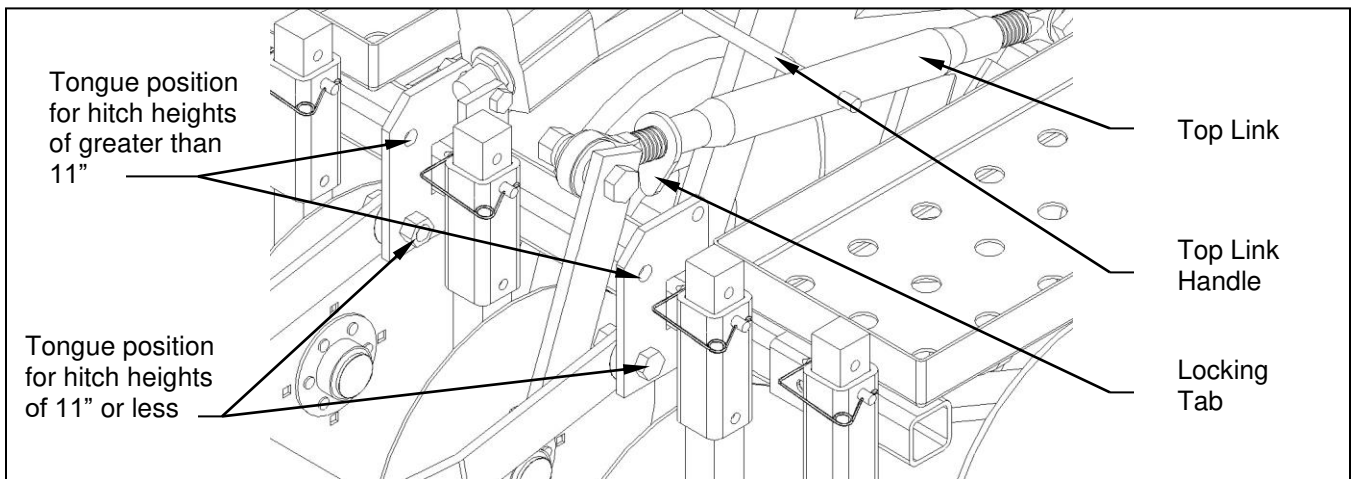

Figure 2. – Tongue Assembly and Adjustment

B. INSTALLATION OF THE LIFT CONTROL WIRING ASSEMBLY

1. Using the provided "U" bolts, securely fasten the lift control panel to the tow vehicle. On most ATVs, the "U" bolts will allow easy installation on the rack.
2. There are two separate electrical cables extending from the lift control panel. There should be a cable that contains battery clips and another cable that has a connector attached to the end. Attach the connector side to the actuator connector. Attach the battery clips to the appropriate terminals on a battery (red attaches to the positive terminal and black to the negative terminal).

Note: Extra electrical cable length can be purchased (**Extension Cable Part #235067**) if needed. In some applications it may be necessary to have extra length to reach the battery or reposition the lift control panel.

3. Securely fasten the electrical cable that extends back to the actuator. Using the provided plastic ties, fasten the cable to the tongue and tow vehicle. Position the disconnect plug such that it can be easily disconnected when the tillage tool is removed from the rear of the tow vehicle.

OPERATIONS AND ADJUSTMENTS



This safety alert symbol is used to indicate safety instructions. Follow these instructions to avoid personal injury and/or property damage. Read and follow all instructions in this manual.



WARNING

Do not allow anyone to operate this equipment who has not fully read and comprehended the safety manual and who has not been properly trained in the safe operation of the equipment.

WARNING

Operator should be familiar with all functions of the unit.

WARNING

Keep bystander clear while operating equipment.

CAUTION

Only operate the tillage tool's electric lift while seated on tow vehicle.

WARNING

Do not store extra coulters or sweeps in an upside down position in the shank receivers.

WARNING

Never carry children or passengers.

CAUTION

Lower implement, stop engine, set brake and remove key before servicing, adjusting, repairing or unplugging.

CAUTION

Safely support and secure implement before making repairs.

CAUTION

Do not stand or climb on equipment.

WARNING

Follow all safety precautions outlined by the manufacturer of the tow vehicle being used to pull this product.

A. INTENDED USE

This tillage tool is intended for use behind an ATV, UTV (utility vehicle / side-by-side) or small sub-compact tractor to till various types of ground and prepare a seedbed.

B. LEVELING THE TOOL

This tool is equipped with a leveling device to adjust for different hitch heights as well as to make the tool level. When adjusted properly, the tool will stay relatively level throughout the height adjustment range.

Note: When leveled, the tool will operate more efficiently in the ground. An unlevelled tool can result in improper coulter or sweep function.

1. Remove the hitch pin from the tongue and attach the tongue to the hitch on the tow vehicle.

- This leveling can be done by adjusting the top link. Unlock the locking tab on the top link. Turning the handle on the top link counter-clockwise will raise the rear end of the tool and clock-wise will lower the rear end of the tool. After adjustments are made, lock the top link in place. **(See Figure 2.)**

Note: Depending on ground conditions, slight adjustments may need to be made after the tool is placed in the ground at the desired depth.

C. COULTER FUNCTION

This model is equipped with five separate coulters. The coulters serve as cutting blades and are meant for light debris cutting, ground scoring for better ground shatter and aiding in reducing clod size. If the debris is not cut the shanks tend to collect debris and act as a rake. This in turn will prevent normal operation. In many cases 150-300lbs of added weight is very effective in helping the coulters to penetrate. If the coulters do not penetrate, then the coulters will not function as effectively. It may take slight leveling adjustments with the top link to provide good coulters penetration as well as sweep depth.

D. SELECTING THE PROPER SWEEP – Refer to Figure 3.

This tool is equipped with two types of sweeps, reversible chisel point sweeps and 9" field cultivator sweeps. Selecting the proper sweep is critical in helping the tool to perform correctly.

The reversible chisel point sweeps are a good choice in hard ground conditions. These sweeps have the ability to easily penetrate and shatter hard ground conditions.

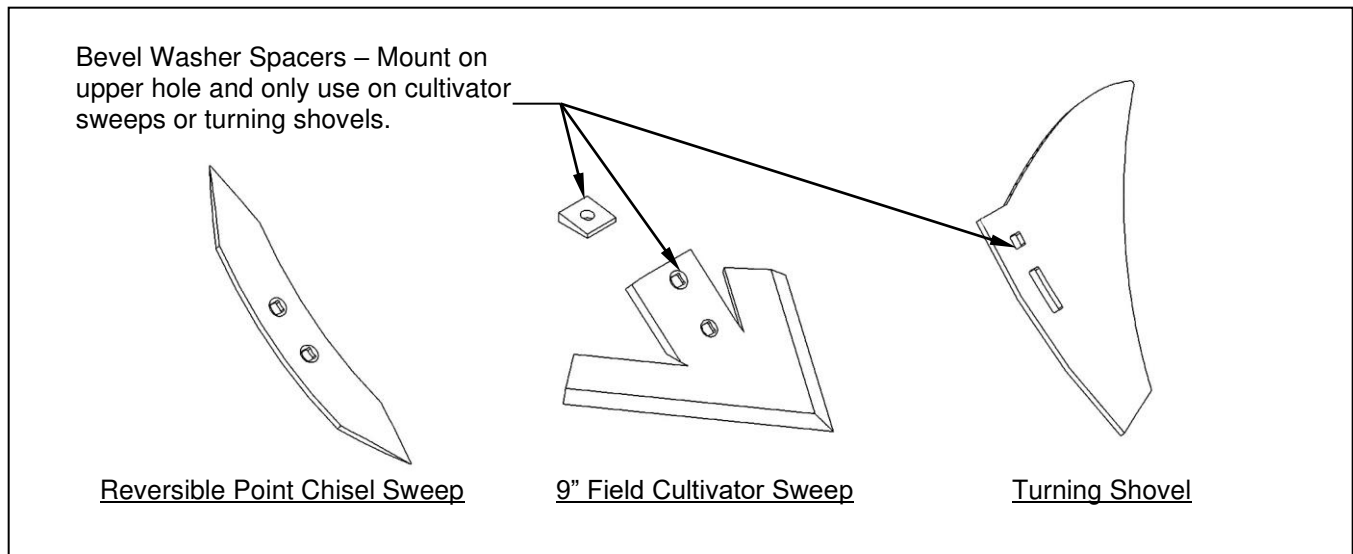

Figure 3. – Sweep Selection

The 9" field cultivator sweeps are typically used for secondary tillage and are a good selection to use after initially breaking hard ground with the chisel point sweeps. The field cultivator sweeps also work well in shearing off weeds. In softer ground conditions, these sweeps can be used for primary tillage. A bevel washer spacer is also provided with these sweeps. This spacer will tip the sweep and provide a steeper more aggressive angle of attack. These washers should only be mounted on the top holes of the sweeps and placed between the shank and the sweep.

Note: An optional turning shovel kit can be purchased (**Part # 003801**). These sweeps are a good choice when working in sod conditions. In hard ground conditions it may be necessary to install the provided bevel washer spacers. These spacers will place the shovels at a steeper more aggressive angle of attack. These washers should only be mounted on the top holes of the shovels and placed between the shank and the shovel.

E. ADJUSTING THE SHANKS AND COULTER SHANKS – Refer to Figure 4.

The shanks and coulters shanks have been designed for quick adjustments. Both removal or maximum depth adjust changes can be made very quickly. The shanks can be set at a maximum depth of 2", 4" or 6" with the tool fully lowered. The coulters shanks can be set at a maximum depth of 2", 3" or 4" with the tool fully lowered. In many cases the tool will function better if the sweeps are set several inches deeper than the coulters.

Note: It is important to re-install the coulters shanks on the proper side of the shank receiver. The coulters should line up with the rear shanks. Improper installation can result in tire coulters interference.

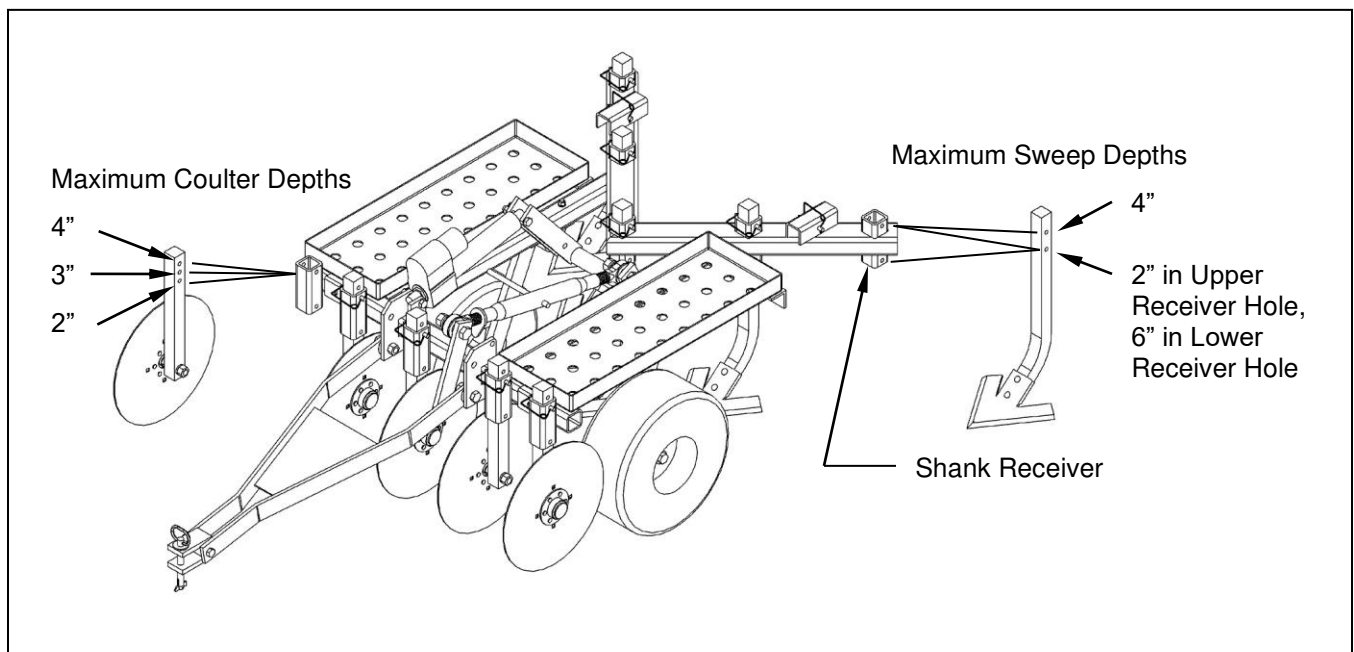

Figure 4. – Shank Adjustment

F. SUGGESTIONS FOR PROPER OPERATION

Proper tool adjustment can increase functionality and efficiency.

Hard Ground

In hard ground conditions, the reversible point chisel sweeps should be installed. The reversible point chisel sweeps have the ability to penetrate hard ground fairly effortlessly without added weight. Additional weight is recommended to help the coulters penetrate. This tillage tool has been equipped with weight racks. These weight racks will easily allow for several hundred pounds to be added to the tool. Depending on what depth the coulters are set at, it is very important to achieve coulters penetration. If the coulters do not penetrate this will be limiting the sweep depth. In these cases it is recommended to raise the coulters to the highest setting or remove them. Removing the coulters or limiting the coulters depth may create a problem in heavy debris conditions. In these conditions it may work best to remove the middle shanks to allow for debris clearing.

Heavy Debris Covered Ground

It is recommended these conditions be mowed first if possible to help chop up the debris. In heavy debris covered conditions, additional weight is recommended to help the coulters penetrate and cut debris. This tillage tool has been equipped with weight racks. These weight racks will easily allow for several hundred pounds to be added to the tool. In certain cases if the debris is too heavy, the coulters may not work even with added weight. In these cases it may be necessary to remove the two middle shanks on the rear of the tool. This will allow the debris to clear the tool with limited collection. Removal or fully raising the middle two coulters will also be necessary to help place more weight on the remaining coulters. **(See Figure 5.)**

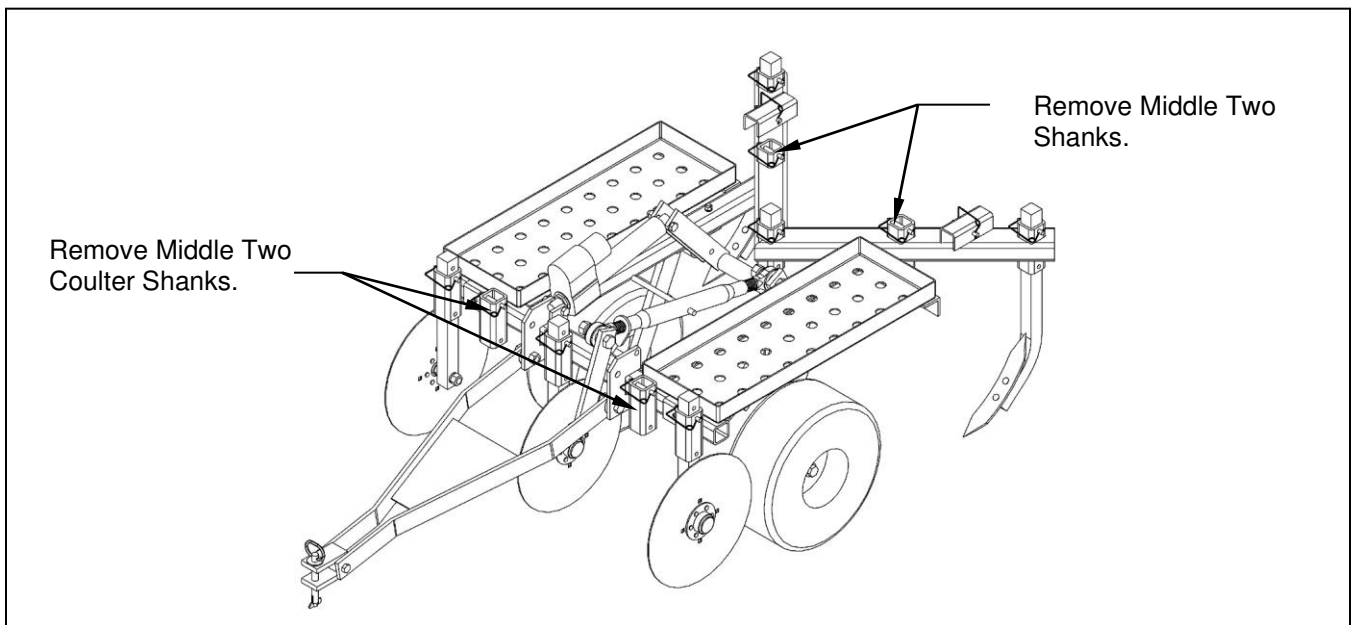

Figure 5. – Suggested Heavy Debris Configuration

Sod Covered Ground

It is recommended that these conditions be mowed and sprayed with a grass killer. A grass killer will not only kill the green growth but will help to break up the root structure as well. Sod is also easier to work with in the spring or shortly after a rain. In some soft ground or limited sod conditions, it may be possible to use the 9" field cultivator sweeps or reversible point chisel sweeps. In most cases the optional turning shovel kit will work best (**Part # 003801**). The turning shovels have the ability to strip the sod off and roll it to the side to prevent collecting on the shanks. In hard ground conditions it may be necessary to install the provided bevel washer spacers shown in Figure 3. These spacers will place the shovels at a steeper more aggressive angle of attack. In all cases additional weight is very helpful to maintain coulters penetration. The coulters will cut the sod which helps prevent collection on the shanks and reduces the pulling load requirements. In heavy sod conditions it may work best to only use two turning shovels. If only two turning shovels are used place the shovels on the shanks closest to the center of the tool. **(See Figure 6.)**

Rock Covered Ground

In most cases reversible point chisel sweeps will have the best chance of working in heavily rock covered ground on the initial pass. These sweeps will provide the least resistance. It may be necessary to raise or remove the coulters. If the coulters are being forced out of the ground due to rocks, it may be difficult to get adequate sweep penetration. Raising or removing the coulters can also help prevent damage to the coulters blades when striking large rocks.

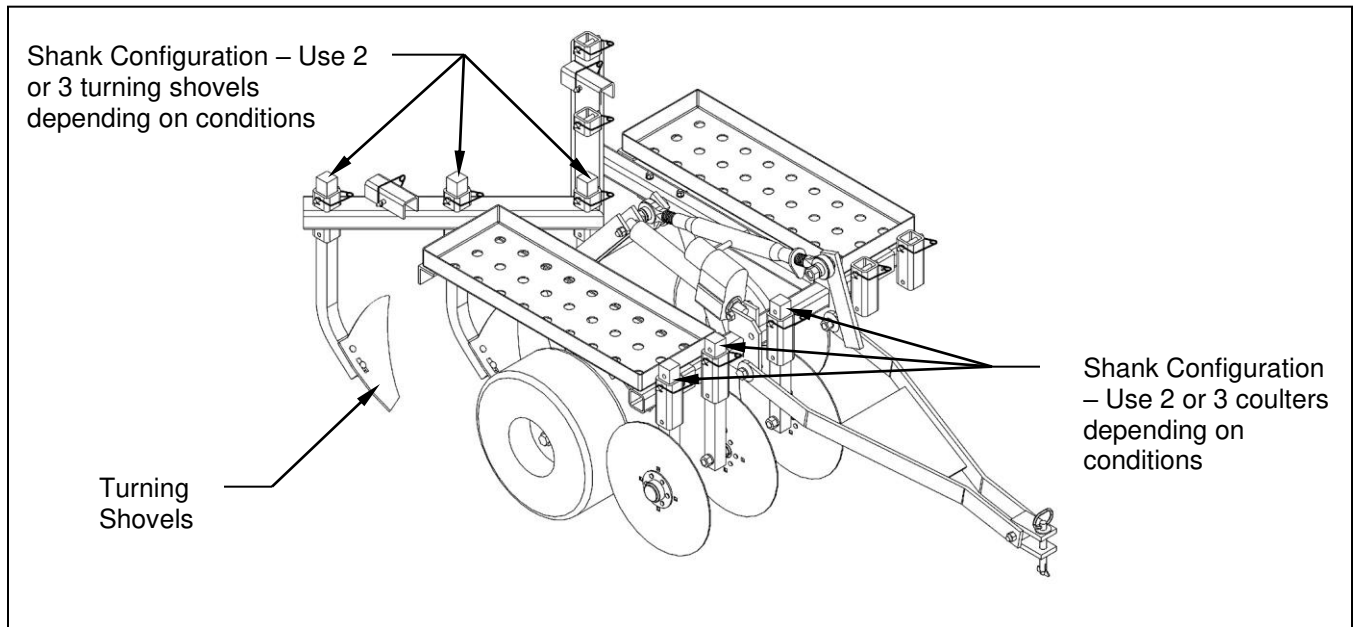

Figure 6. – Turning Shovel Configuration

Soft Ground Conditions or Previously Tilled Ground

Soft ground conditions can be performed with any of the sweeps. The 9" field cultivator sweeps tend to work the best in these cases. These sweeps will help to fully shear the ground off and create a true seedbed. The optional drag harrow kit (**Part # 003800**) can be added as well for these conditions. The drag harrow will help to level the ground and reduce clod size. If there is limited debris, the coulters can be removed. With the coulters removed the two center sweeps can be moved forward. (**See Figure 7.**)

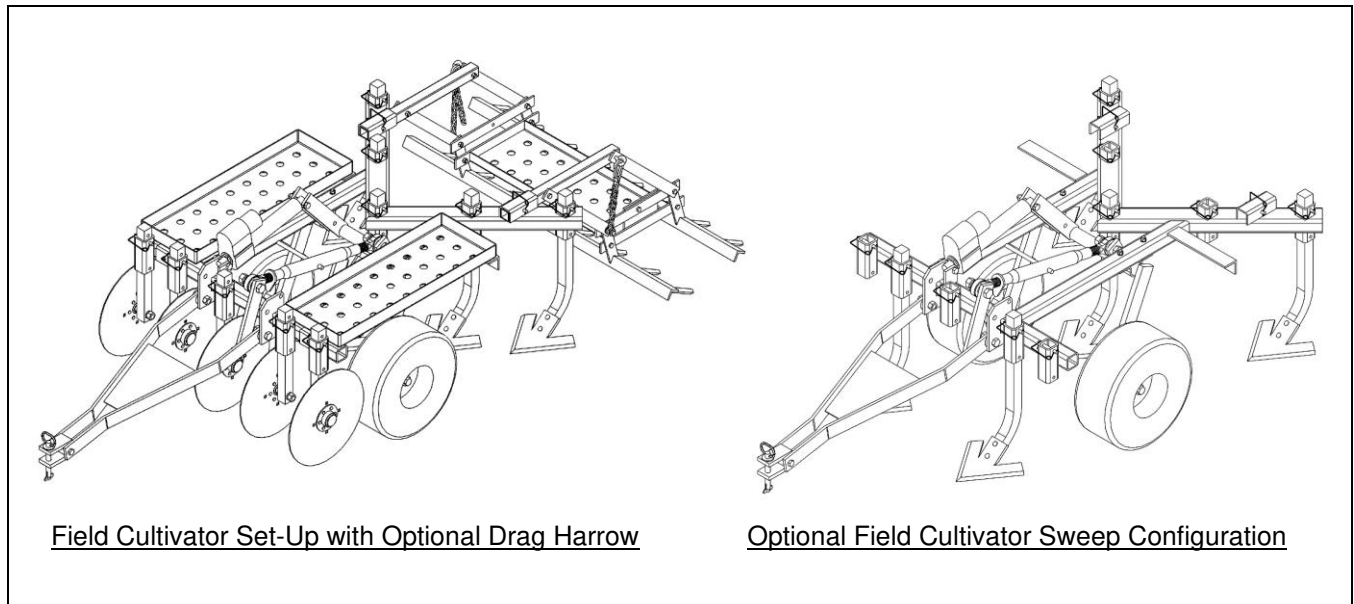
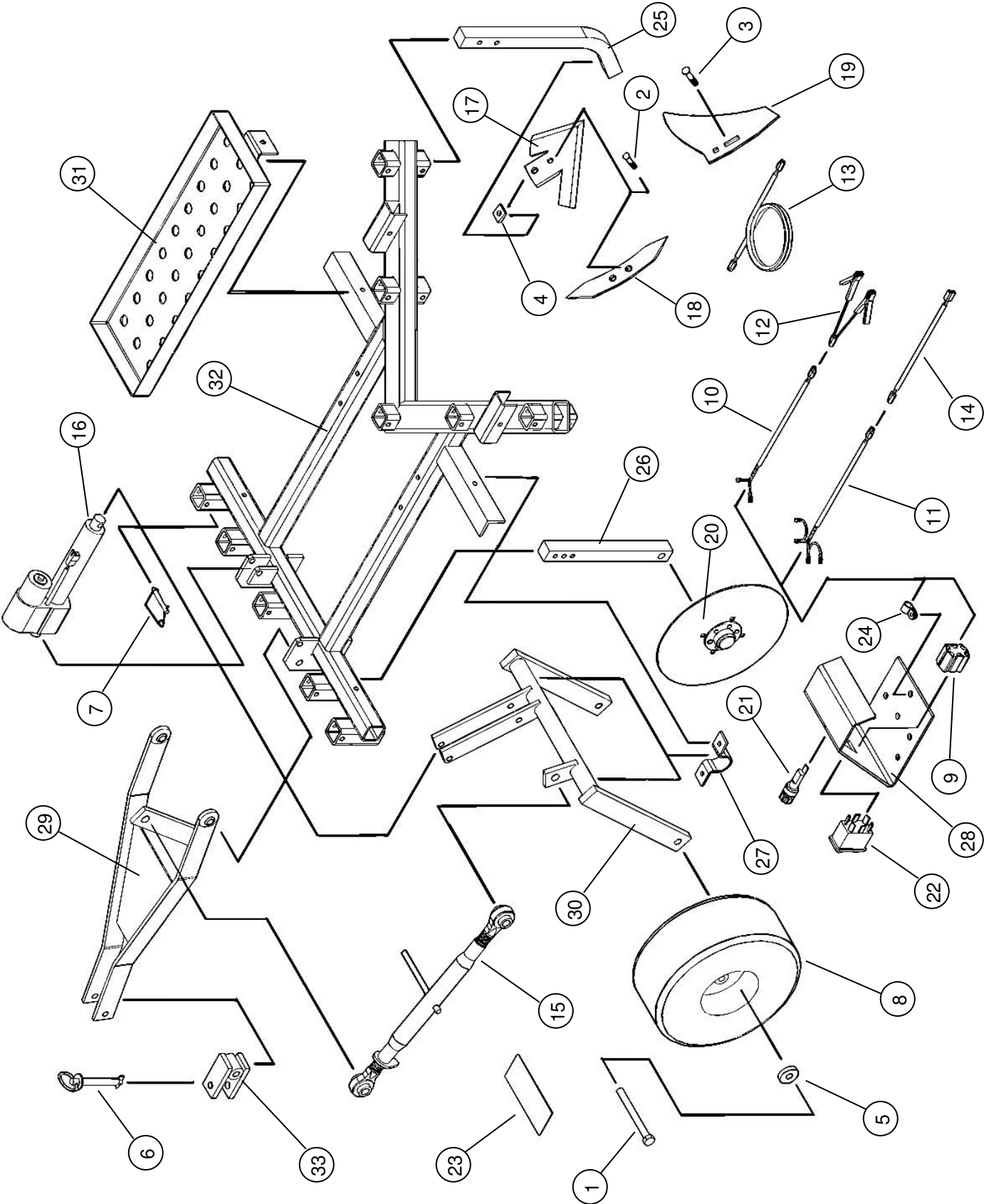

Figure 7. – Field Cultivator Configurations

MODEL 543 PARTS LIST

<u>Item</u>	<u>Part #</u>	<u>Description</u>	<u>Quantity</u>
1	202147	Hex Head Cap Screw (5/8-11 x 6.50)	2
2	204012	Plow Bolt (3/8"-16 x 2-1/4", 3/8 Sq.)	10
3	204013	Plow Bolt (7/16"-14 x 2-1/2", 7/16 Sq.)	Optional
4	214025	Bevel Washer Spacer	5
5	214030	Cup Washer	2
6	216012	Tension Lock Pin (5/8" Dia. x 3-1/2" Long)	1
7	216013	Wire Lock Pin (3/8" Dia. x 2-1/4" Long)	10
8	226012	Offset Wheel Assy., Pneumatic Turf Tread 4 Ply (15/600 x 6)	2
	243015	Precision Sealed Wheel Bearings (2" O.D. x 1" I.D.)	4
9	235061	Six Contact Socket Connector	1
10	235063	Battery Wiring Harness	1
11	235065	Wiring Harness	1
12	235066	Battery Clip Harness	1
13	235067	Extension Cable	Optional
14	235070	Actuator Wiring Harness Assy.	1
15	237001	Forged Top Link	1
16	237002	Electric Linear Actuator (8" Stroke)	1
17	259003	9" Field Cultivator Sweep	5
18	259004	Reversible Chisel Point Sweep	5
19	259005	Turning Shovel	Optional
20	259006	Coulter Blade, 13.5"	5
21	264006	Fuse Holder	1
22	264008	Rocker Switch	1
23	275018	Till-Ease Name Decal	2
23	275019	Kunz Decal	1
23	275020	Lift Control Decal	1
24	277030	Fixed Diameter Cable Clamp	2
25	500007	Shank	5
26	500008	Coulter Shank	5
27	500009	Axle Clamp	2
28	500010	Control Panel	1
29	800000	Tongue	1
30	800001	Lift Assembly	1
31	800008	Weight Rack	2
32	800010	Tool Frame	1
33	800018	Tongue Clevis	1

MODEL 543 PARTS



Till-Ease Tillage Equipment Warranty Policy

- 1. Kunz Engineering, Inc., warrants to the owner that each new product is free of defects in workmanship and material for the length of 12 months from the date of purchase. Kunz Engineering, Inc., agrees to provide replacement parts for any defective parts at no charge to the owner. The customer is responsible for transportation of the equipment to and from the dealer.**
- 2. All warranty parts must be replaced with original factory parts.**
- 3. Parts will be shipped by regular ground delivery. If next day or second day service is required, the customer will be responsible for additional shipping costs.**
- 4. This warranty will not cover parts damaged for the following reasons:**
 - a. Failure to follow proper set-up procedures outlined in the Owner's Manual**
 - b. Operator misuse or neglect**
 - c. Accidents**
 - d. Design alterations**
 - e. Repairs not done according to manufacturer's instructions**
 - f. Commercial, rental, or municipality use of a homeowner model**
- 5. Normal wear items such as sweeps/shovels, coulters, tires, packer wheels and bearings will not be covered under this warranty unless the original part is shown to be defective.**